

# Panasonic

## **Cordless** Hammer Drill & Driver

### Operating Instructions

Model No. : EY6931

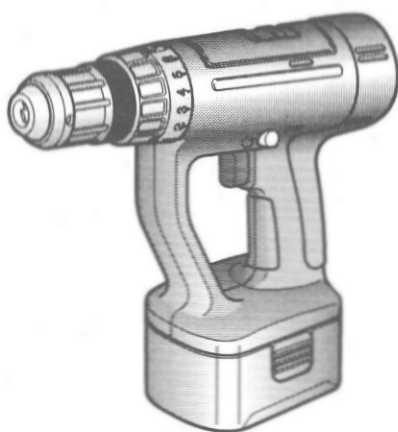

#### **IMPORTANT**

This manual contains safety information. Read manual completely before first using this product and save this manual for future use.

SAVE THESE INSTRUCTIONS

# GENERAL SAFETY RULES- FOR ALL BATTERY OPERATED TOOLS

## WARNING!

Read and understand all instructions.

- Failure to follow all instructions listed below, may result in electric shock, fire and/or serious personal injury.

## SAVE THESE INSTRUCTIONS

### Work Area

- 1) **Keep your work area clean and well lit.**  
Cluttered benches and dark areas invite accidents.
- 2) **Do not operate power tools in explosive atmospheres, such as in the presence of flammable liquids, gases, or dust.**  
Power tools create sparks which may ignite the dust or fumes.
- 3) **Keep bystanders, children, and visitors away while operating a power tool.**  
Distractions can cause you to lose control. Make sure that no one is beneath, or on the other side of the area when you are working.

### Electrical Safety

- 4) **A battery operated tool with integral batteries or a separate battery pack must be recharged only with the specified charger for the battery.**  
A charger that may be suitable for one type of battery may create a risk of fire when used with another battery.
- 5) **Use battery operated tool only with specifically designated battery pack.**  
Use of any other batteries may create a risk of fire.

### Personal Safety

- 6) **Stay alert, watch what you are doing, and use common sense when operating a power tool. Do not use tool while tired or under the influence of drugs, alcohol, or medication.**  
A moment of inattention while operating power tools may result in serious personal injury.
- 7) **Dress properly. Do not wear loose clothing or jewelry. Contain long hair. Keep your hair, clothing, and gloves away from moving parts.**  
Loose clothes, jewelry, or long hair can be caught in moving parts.
- 8) **Avoid accidental starting. Be sure switch is in the locked or off position before inserting battery pack.**  
Carrying tools with your finger on the switch or inserting the battery pack into a tool with the switch on invites accidents.
- 9) **Remove adjusting keys or wrenches before turning the tool on.**  
A wrench or a key that is left attached to a rotating part of the tool may result in personal injury.
- 10) **Do not overreach. Keep proper footing and balance at all times.**  
Proper footing and balance enable better control of the tool in unexpected situations.
- 11) **Use safety equipment. Always wear eye protection.**  
Dust mask, non-skid safety shoes, hard hat, or hearing protection must be used for appropriate conditions.
- 12) **Use clamps or other practical way to secure and support the workpiece to a stable platform.**  
Holding the work by hand or against your body is unstable and may lead to loss of control.

**13) Do not force tool. Use the correct tool for your application.**

The correct tool will do the job better and safer at the rate for which it is designed.

**14) Do not use tool if switch does not turn it on or off.**

A tool that cannot be controlled with the switch is dangerous and must be repaired.

**15) Disconnect battery pack from tool or place the switch in the locked or off position before making any adjustments, changing accessories, or storing the tool.**

Such preventive safety measures reduce the risk of starting the tool accidentally.

**16) Store idle tools out of reach of children and other untrained persons.**

Tools are dangerous in the hands of untrained users.

**17) When battery pack is not in use, keep it away from other metal objects like: paper clips, coins, keys, nails, screws, or other small metal objects that can make a connection from one terminal to another.**

Shorting the battery terminals together may cause sparks, burns or a fire.

**18) Maintain tools with care. Keep cutting tools sharp and clean.**

Properly maintained tools with sharp cutting edge are less likely to bind and are easier to control.

**19) Check for misalignment or binding of moving parts, breakage of parts, and any other condition that may affect the tool's operations. If damaged, have the tool serviced before using.**

Many accidents are caused by poorly maintained tools.

**20) Use only accessories that are recommended by the manufacturer for your model.**

Accessories that may be suitable for one tool may create a risk of injury when used on another tool.

## Service

**21) Tool service must be performed only by qualified repair personnel.**

Service or maintenance performed by unqualified personnel may result in a risk of injury.

**22) When servicing a tool, use only identical replacement parts. Follow instructions in the Maintenance section of this manual.**

Use of unauthorized parts or failure to follow Maintenance Instructions may create a risk of shock or injury.

## SPECIFIC SAFETY RULES

**1) Hold tool by insulated gripping surfaces when performing an operation where the cutting tool may contact hidden wiring.**

Contact with a "live" wire will make exposed metal parts of the tool "live" and shock the operator.

**2) Wear ear protectors when using the tool for extended periods.**

Prolonged exposure to high intensity noise can cause hearing loss.

**3) Be aware that this tool is always in an operating condition, it does not have to be plugged into an electrical outlet.**

**4) Do not operate the reversing lever when the main switch is on.**





The battery will discharge rapidly and damage to the unit may occur.

**5) If the bit becomes jammed, immediately turn the main switch off to prevent an overload which can damage the battery pack or motor. Use reverse motion to loosen jammed bits.**

**6) When storing or carrying the tool, set the reversing lever to the center (switch lock) position.**

**7) Do not strain the tool by holding the speed control trigger halfway (speed control mode) so that the motor stops.**

- 8) During charging, the charger may become slightly warm. This is normal. Do not charge the battery for a long period.

Symbol	Meaning
V	Volts
	Direct Current
no	no load speed
.../min	revolutions or reciprocation per minutes
	Forward Rotation
	Reverse Rotation
	Rotation with Hammering
	Rotation only

## FOR BATTERY CHARGER & BATTERY PACK

### 1) SAVE THESE INSTRUCTIONS -This

manual contains important safety and operating instructions for battery charger EY0230.

- 2) Before using battery charger, read all instructions and cautionary markings on (1) battery charger, (2) battery pack.
- 3) **CAUTION** -To reduce the risk of injury, charge only Battery Pack as shown below.  
EY9103, EY9101, EY9001, EY9006, EY9180, EY9080, EY9182, EY9086, EY9065, EY9066, EY9106, EY9107, EY9136, EY9117, EY9230, EY9200, EY9108, EY9168  
Other types of batteries may burst causing personal injury and damage.
- 4) Do not expose charger to rain or snow.
- 5) To reduce risk of damaging the electric plug and cord, pull by plug rather than cord when disconnecting charger.
- 6) Make sure cord is located so that it will not be stepped on, tripped over, or otherwise subjected to damage or stress.

- 7) An extension cord should not be used unless absolutely necessary. Use of improper extension cord could result in a risk of fire and electric shock. If extension cord must be used, make sure:
- that pins on plug of extension cord are the same number, size and shape as those of plug on charger.
  - that extension cord is properly wired and in good electrical condition.
  - that wire size is large enough for ampere rating of charger as specified below.

RECOMMENDED MINIMUM AWG SIZE OF EXTENSION CORDS FOR BATTERY CHARGERS					
AC Input Rating.	Amperes	AWG Size of Cord			
Equal to or greater than	But less than	Length of Cord, Feet			
		25	50	100	150
0	2	18	18	18	16

- Do not operate charger with damaged cord or plug—replace them immediately.
- Do not operate charger if it has received a sharp blow, been dropped, or otherwise damaged in any way; take it to a qualified serviceman.
- Do not disassemble charger; take it to a qualified serviceman when service or repair is required. Incorrect reassembly may result in a risk of electric shock or fire.
- To reduce the risk of electric shock, unplug charger from outlet before attempting any maintenance or cleaning.
- The charger and battery pack are specifically designed to work together. Do not attempt to charge any other cordless tool or battery pack with this charger.
- Do not attempt to charge the battery pack with any other charger.
- Do not attempt to disassemble the battery pack housing.

- Do not store the tool and battery pack in locations where the temperature may reach or exceed 122°F (50°C) (such a metal tool shed, or a car in the summer), which can lead to deterioration of the storage battery.
- Do not charge battery pack when the temperature is BELOW 32°F (0°C) or ABOVE 104°F (40°C). This is very important.
- Do not incinerate the battery pack. It can explode in a fire.
- Avoid dangerous environment. Do not use charger in damp or wet locations.
- The charger is designed to operate on standard household electrical power only. Do not attempt to use it on any other voltage!
- Do not abuse cord. Never carry charger by cord or yank it to disconnect from outlet. Keep cord away from heat, oil and sharp edges.
- Charge the battery pack in a well ventilated place, do not cover the charger and battery pack with a cloth, etc., while charging.
- Use of an attachment not recommended may result in a risk of fire, electric shock, or injury to persons.
- Do not short the battery pack. A battery short can cause a large current flow, over heating and burns.
- NOTE: If the supply cord of this appliance is damaged, it must only be replaced by a repair shop appointed by the manufacturer, because special purpose tools are required.
- TO REDUCE THE RISK OF ELECTRIC SHOCK, THIS APPLIANCE HAS A POLARIZED PLUG (ONE BLADE IS WIDER THAN THE OTHER). This plug will fit in a polarized outlet only one way. If the plug does not fit fully in the outlet, reverse the plug. If it still does not fit, contact a qualified electrician to install the proper outlet. Do not change the plug in any way.

# FUNCTIONAL DESCRIPTION

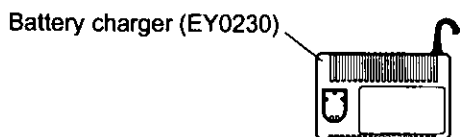
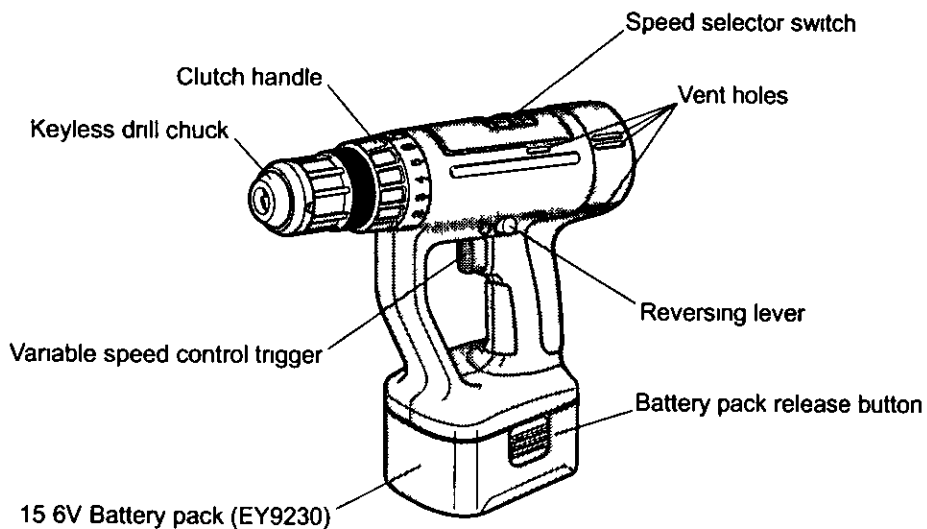

# ASSEMBLY

## Attaching or removing bit

**Note:** When attaching or removing a bit, disconnect battery pack from tool or place the switch in the center position. (switch lock)

This tool is equipped with a keyless drill chuck.

### 1. Attachment

Insert the bit and turn the lock collar clockwise (looking from the front) to tighten firmly.

Slide the Lock collar to LOCK side until it snaps.

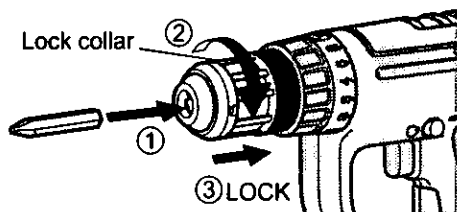

### 2. Removal

Slide the Lock collar to FREE side.

Turn the lock collar counterclockwise (looking from the front), then remove the bit.

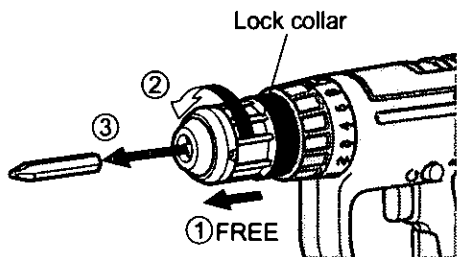

**Note:** If excessive play occurs in the chuck,

- 1 secure the drill in place and tighten the chuck by turning clockwise,
- 2 open the chuck jaws by unscrewing the lock collar and
- 3 tighten the screw (left-handed screw) with a screwdriver by turning it counterclockwise (viewed from the front).

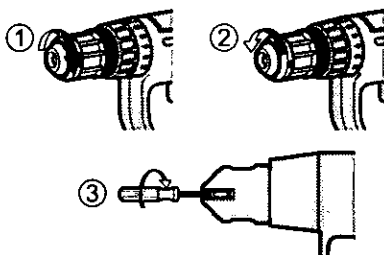

## Attaching or removing battery pack

### 1. To connect the battery pack:

Insert the battery pack. It snaps into place to indicate proper connection.

### 2. To remove the battery pack:

Press the two buttons on the sides of the battery pack. Slide the battery pack out of the tool body.

## OPERATION

### Switch Operation

1. The speed increases with the amount of depression of the trigger. When beginning work, depress the trigger slightly to start the rotation slowly.
2. A feedback electronic controller is used to give a strong torque even in low speed.
3. The brake operates when the trigger is released and the motor stops immediately.

**Note:** When the brake operates, a braking sound may be heard. This is normal.

### Reversing Switch Operation



(Forward (⌚), Switch lock, Reverse (⌚))

**CAUTION:** Do not operate reversing lever until the chuck comes to a complete stop. Shifting during rotation of the chuck may damage the tool.

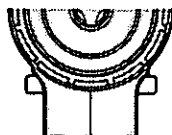
1. For reverse rotation, set the lever to reverse. Check the direction of rotation before use.
2. After use, set the lever to its center position (switch lock).



## Clutch Torque Setting



Adjust the torque to one of the 5 possible settings or "  ", "  " position to the job

**CAUTION:** Test the setting before actual operation

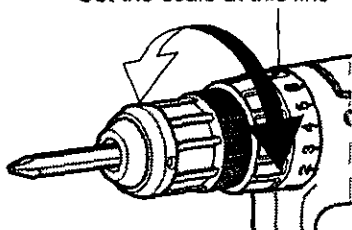
Set the scale at this line



## Reference for Adjusting Torque

Scale	Torque	Use
1	Approx 1.0 Nm (10 kgf-cm or 8.7 in-lbs)	For driving terminal screws
2	Approx 1.5 Nm (15 kgf-cm or 13.0 in-lbs)	For driving machine screws
3	Approx 2.5 Nm (25 kgf-cm or 21.7 in-lbs)	For driving screws into soft materials
4	Approx 3.4 Nm (35 kgf-cm or 30.47 in-lbs)	For driving screws into hardwood
5	Approx 4.4 Nm (45 kgf-cm or 39.0 in-lbs)	
	For powerful driving and drilling	
	Percussion	For drilling to mortar, brick, etc

## Bit-locking function

- 1 With the trigger switch not engaged and a screwdriver bit locked in place, the tool can be used as a manual screwdriver (up to 22.6 Nm, 230 kgf-cm, 199 in-lbs)  
There will be a little play in the chuck, but this is not a malfunction
- 2 This feature is handy for tightening screws that require more torque than the maximum torque of the driver (position  on the clutch), for confirming the tightness of a screw or to loosen an extremely tight screw

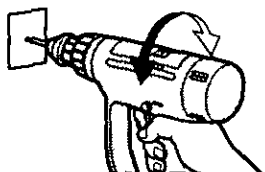

## Speed Selection

Choose a low or high speed to suit the use  
The more the speed control trigger is pulled, the higher the speed

	No load speed	Torque
LOW	80 - 550/min (rpm)	Strong
HIGH	300 - 2000/min (rpm)	Weak

- CAUTION:**
- Check the speed selector switch before use
  - Use at low speed when strong force is needed during operation (Using at high speed while a strong force is applied may cause a motor breakdown)
  - See appendix for "RECOMMENDED SPEED SELECTION"

## For Appropriate use of Battery pack

### Ni-MH Battery pack EY9230

- Charge the Ni-MH battery fully before storage in order to ensure a longer service life
- The ambient temperature range is between 0°C and 40°C  
If the battery pack is used when the battery temperature is below 0°C, the tool may fail to function properly. In that case, charge the battery until charging is completed for appropriate functioning of the battery
- When operating with a Ni-MH battery pack, make sure the place is well-ventilated

## Battery Pack Life

The rechargeable batteries have a limited life. If operation time becomes extremely short after recharging, replace the battery pack with a new one

**Note** Use under extremely hot or cold conditions will reduce operating capacity per charge.



# Charging

**Note.** When you charge the battery pack for the first time, or after prolonged storage, charge it for about 24 hours to bring the batteries up to full capacity

## EY0230

1 Plug the charger into the AC outlet

**Note:** Sparks may be produced when the plug is inserted into the AC power supply, but this is not a problem in terms of safety

2 Insert the battery pack firmly into the charger

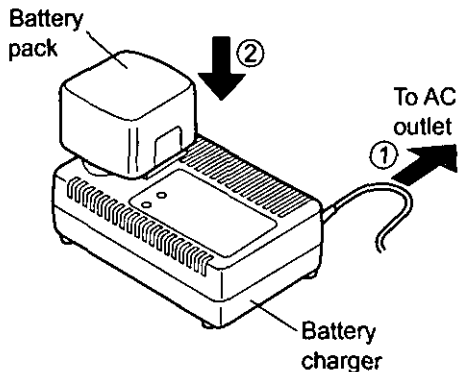

3 During charging, the charging lamp will be lit

When charging is completed, an internal electronic switch will automatically be triggered to prevent overcharging

- Charging will not start if the battery pack is warm (for example, immediately after heavy-duty operation)

The orange standby lamp will be lit until the battery cools down. Charging will then begin automatically

4 When charging is completed, the charging lamp will start flashing rapidly

5 When in any of the conditions that battery pack is too cool, or the battery pack has not been used for a long time, the charging lamp starts flashing slowly to indicate protective charging. Protective charging takes longer to fully charge the battery pack, than the standard charging time (Max charging time is approx 90 minutes)

- If a fully charged battery pack is inserted into the charger again, the charging lamp may light up and then flash slowly. After several minutes, the charging lamp may flash quickly to indicate the charging is completed

6 If the charging lamp does not light immediately after the charger is plugged in, or if after the standard charging time the lamp does not go off, consult an authorized dealer

**Note:**

- When charging a cool battery pack (below 5°C) in a warm place, leave the battery pack at the place and wait for more than one hour to warm up the battery to the level of the ambient temperature (Battery pack may not be fully charged)

- Cool down the charger when charging more than two battery packs consecutively

- Do not insert your fingers into contact hole, when holding charger or any other occasions

**CAUTION**

- Do not use power source from an engine generator

- Do not cover vent holes on the charger and the battery pack

# LAMP INDICATIONS

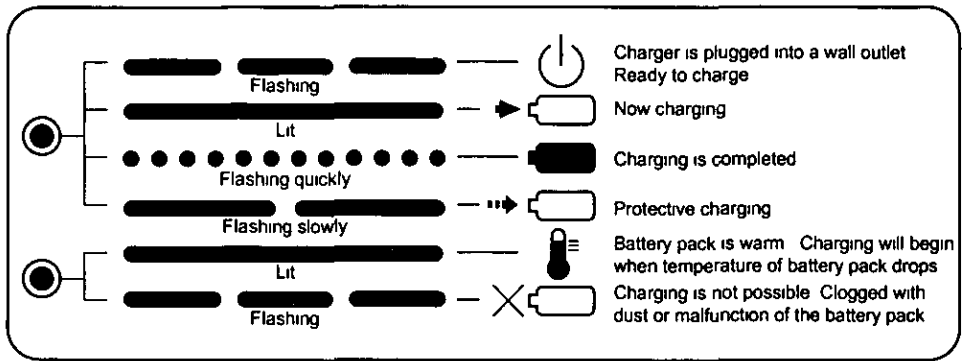

## MAINTENANCE

Use only a dry, soft cloth for wiping the unit  
Do not use a damp cloth, thinner, benzene,  
or other volatile solvents for cleaning

## ACCESSORIES

Use only bits suitable for size of drill's  
chuck

## RECOMMENDED SPEED SELECTION

- CAUTION** • USE AT LOW SPEED WHEN STRONG FORCE IS NEEDED DURING OPERATION  
(Using at high speed while a strong force is applied may cause a motor breakdown )
- Use the following as a guide to select low or high speed for the job

EY6931

MATERIAL/ CONDITION	DRILLING				SCREW TIGHTENING
	MORTAR / BRICK	WOOD / YELLOW PINE	METAL	METAL HOLE SAW	Wood screws
HIGH	ø 10 mm (3/8") or less	Thickness 40 mm (1 37/64") or less	Cold-rolled steel plate (SPC) Thickness 1.6 mm (1/16") or less	Not used	
LOW	ø 13 mm (1/2") or less (Slow operation)	ø 36 mm (1-27/64") or less	ø 13 mm (1/2") or less	ø 34 mm (1-11/ 32") or less	ø 6.8 mm (17/64") or less

# SPECIFICATIONS

## MAIN UNIT

Model		EY6931	
Capability	Screw driving	Machine screw	M3 ~ M6
		Wood screw	ø 2.1 ~ ø 6.8 mm (5/64" ~ 17/64")
		Masonry screw	ø 4 ~ ø 6 mm (5/32" ~ 15/64")
	Drilling	Mortar/Brick	ø 3 ~ ø 13 mm (1/8" ~ 1/2")
		Wood	ø 3 ~ ø 36 mm (1/8" ~ 1-27/64")
		Metal	ø 1.5 ~ ø 13 mm (1/16" ~ 1/2")
	Metal hole saw	Max ø 34 mm (1-11/32")	
Motor		DC Motor 15.6 V	
No load speed	LOW	80 ~ 550/min (rpm)	
	HIGH	300 ~ 2000/min (rpm)	
Blows rate per minute	LOW	1200 ~ 8250/min (bpm)	
	HIGH	4500 ~ 30000/min (bpm)	
Chuck capacity		ø 1.5 ~ ø 13 mm (1/16" ~ 1/2")	
Blow strength		1.7 kN, (173 kgf, 370 lbs f)	
Overall length		236 mm (10-23/32")	
Weight (with battery pack)		2.3 kg, (5.1 lbs)	

## BATTERY PACK

Model	EY9230
Storage battery	Ni-MH Battery
Battery voltage	15.6 V DC (1.2 V × 13 cells)

## BATTERY CHARGER

Model	EY0230				
Electrical Rating	See the name plate on the bottom of the charger				
Weight	0.78 kg, (1.72 lbs)				
Charging time	15.6 V	12 V	9.6 V	7.2 V	Standard charging time
	-	EY9001 EY9006	EY9080 EY9086	EY9065 EY9066	Approx 20 min
	-	EY9101	EY9180 EY9182	-	Approx 25 min
	EY9136	EY9106 EY9107 EY9108	-	EY9168	Approx 30 min
	EY9230	EY9200	-	-	Approx 45 min

**Note** This chart may include models that are not available in your area  
Please refer to the catalogue

**30-DAY QUALITY  
SATISFACTION GUARANTEE:**

If you are dissatisfied with any Panasonic Cordless Power Tool for any reason, simply return it to the place of purchase with a dated proof of purchase, in the original packaging, with all accessories, parts and instructions, within 30 days of the date of purchase, for a full refund, or call Panasonic at 201-392-6655. Abuse or misapplication of any power tool voids the guarantee.

**PANASONIC HOME & COMMERCIAL PRODUCTS COMPANY**

One Panasonic Way, Secaucus, New Jersey 07094